

RAK19007 WisBlock Base Board 2nd Gen Datasheet

WisBlock Base Board 2nd Gen Overview

RAK19007 is a **WisBlock Base Board 2nd Gen** that connects **WisBlock Core**, **WisBlock IO**, and **WisBlock Modules**. It provides the power supply and interconnection to the modules attached to it. It has one slot reserved for the WisBlock Core module and four slots A-D for WisBlock modules. The WisBlock Core is attached on the top side, and the WisBlock modules are attached to the top or bottom side of the RAK19007. The Slot D holds modules up to 23 mm in size, while slots A to C support 10 mm WisBlock modules. Also, there are three **2.54 mm pitch headers** for extension interface with **BOOT**, **GPIO**, **I2C**, and **UART** pins.

For convenience, there is a Type-C USB connector that is connected directly to WisBlock Core MCU's USB port (if supported) or to a USB-UART converter depending on the WisBlock Core. It can be used for uploading firmware or serial communication. The USB-C connector is also used as a battery charging port.

WisBlock modules are connected to the RAK19007 WisBlock Base board via high-speed board-to-board connectors. They provide secure and reliable interconnection to ensure the signal integrity of each data bus. A set of screws are used for fixing the modules, which makes it reliable even in an environment with lots of vibrations.

You can also use a [RAK19005 WisBlock Sensor Extension Cable](#) to position the WisBlock modules apart from the WisBlock Base board or in any part of your case.

RAK19007 has connectors for the following:

- 1 WisBlock Core module
- 1 WisBlock compatible with IO slot
- 4 WisBlock modules compatible with slots A-D
- 1 Type-C USB port for programming and debugging
- 3.7 V Rechargeable battery connector
- 5 V Solar panel connector
- Four 4-pin header with BOOT, I2C, and UART pins accessible with solder contacts

Additionally, it has two user-definable LEDs, one power supply/charging indicator LED, and a reset button.

NOTE:

Improvements from RAK5005-O Base board

- J11 header Analog input changed from AIN0 to AIN1.
- Upgraded to USB C connector.
- Slot D position changed with added TX1/RX1 availability to it.

If you can't find a WisBlock module that fits your IoT requirements, use the standard connectors of WisBlock to develop your specific function module. WisBlock supports open-source hardware architecture and you can find tutorials showing how to create your own [Awesome WisBlock](#) module.

Applications

- Wireless Sensor Network
- Environmental monitoring
- Wireless data transmission
- Data acquisition in the industrial environment

- Location and tracking of personnel or moving objects

Main Features

- Flexible building block design, which enables modular function realization and expansion
- High-speed interconnection connectors in the WisBlock Base Board 2nd Gen Board to ensure signal integrity
- Supports multiple types of low power MCUs
- Supports multiple types of sensors. A single board can support a combination of two different types of sensors
- Low power battery power supply
- Supports lithium battery charging
- Supports solar panel charging
- Fulfills industrial level design
- Compact size: 30 x 60 mm

Specifications

Overview

There are six (6) slots on RAK19007 WisBlock Base Board 2nd Gen:

- **CPU SLOT:** This slot is reserved for the WisBlock Core module which has the main MCU.
- **IO SLOT:** This slot is used for IO extension modules.
- **Four Sensor Slots:** The sensor slots A to D are used to connect with the I2C bus. Slot D can be used for GNSS modules, too.

Also, there are three (3) 2.54 mm pitch hole pads for extension interface such as BOOT, I2C, UART, and GPIO pins.

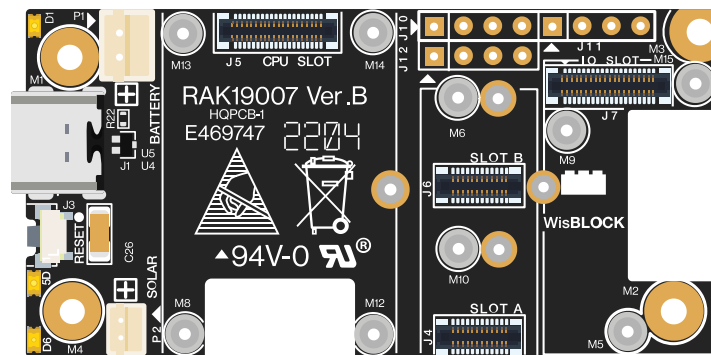

Figure 1: WisBlock Base Board 2nd Gen top view

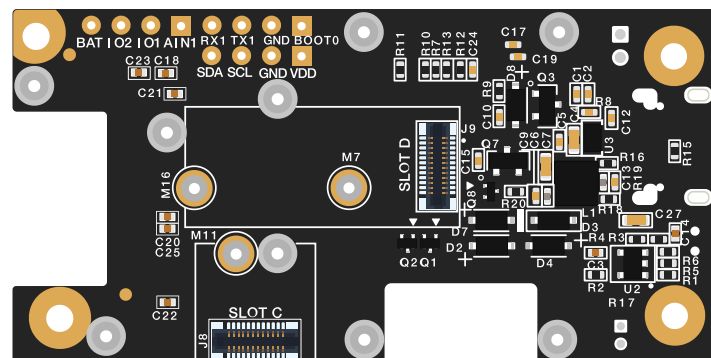

Figure 2: WisBlock Base Board 2nd Gen bottom view

Block Diagram

The block diagram in **Figure 3** shows the internal architecture and external interfaces of the RAK19007 board.

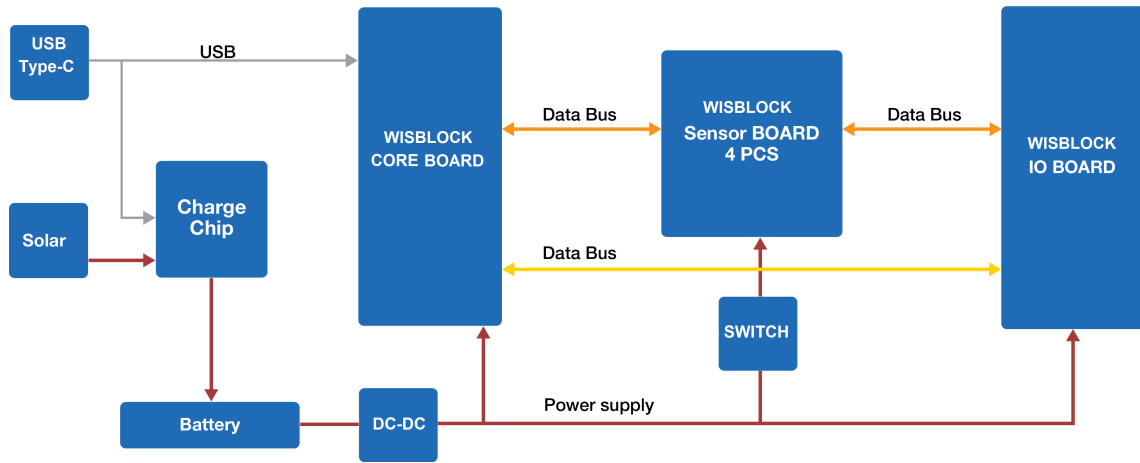

Figure 3: RAK19007 WisBlock Base Board 2nd Gen block diagram

Hardware

The hardware specification is categorized into six parts. It shows the interfacing, pinouts and the corresponding functions and diagrams. It also presents the electrical, environmental, and mechanical parameters that include the tabular data of the functionalities and standard values of the RAK19007 WisBlock Base Board 2nd Gen.

Interfaces

RAK19007 WisBlock Base Board 2nd Gen provides the following interfaces, headers, a button, and WisBlock Connectors.

- One Type-C USB connector
- One connector for CPU slot
- One connector for the IO slot
- Four connectors for WisBlock sensor modules (slots A to D)
- Three 4-pin header 2.54 mm hole pads (GPIO, UART, I2C, Power)
- 2-pin battery interface
- 2-pin solar panel interface

Additionally, the RAK19007 has two user-definable LEDs, one power supply/charging indicator LED, and a reset button.

Figure 4 and Figure 5 show the location of RAK19007 main components.

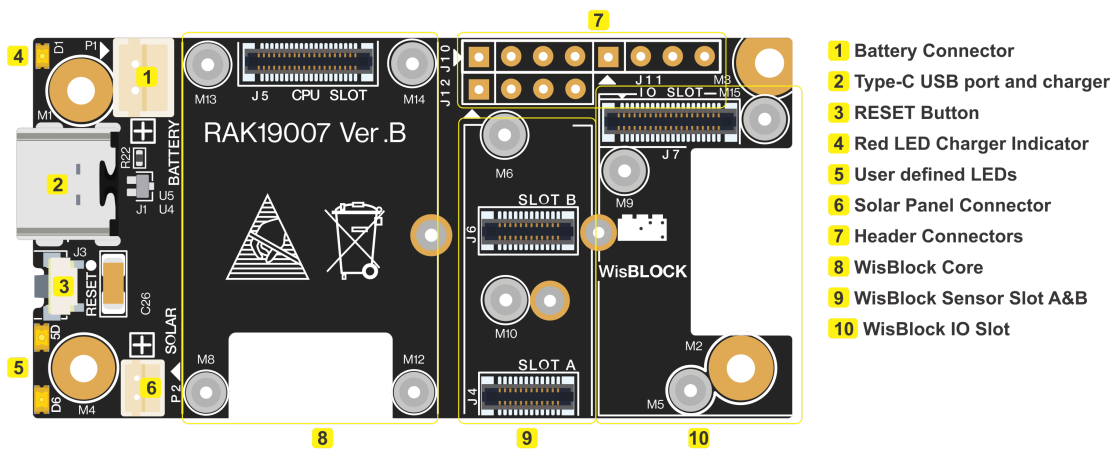

Figure 4: RAK19007 top view components

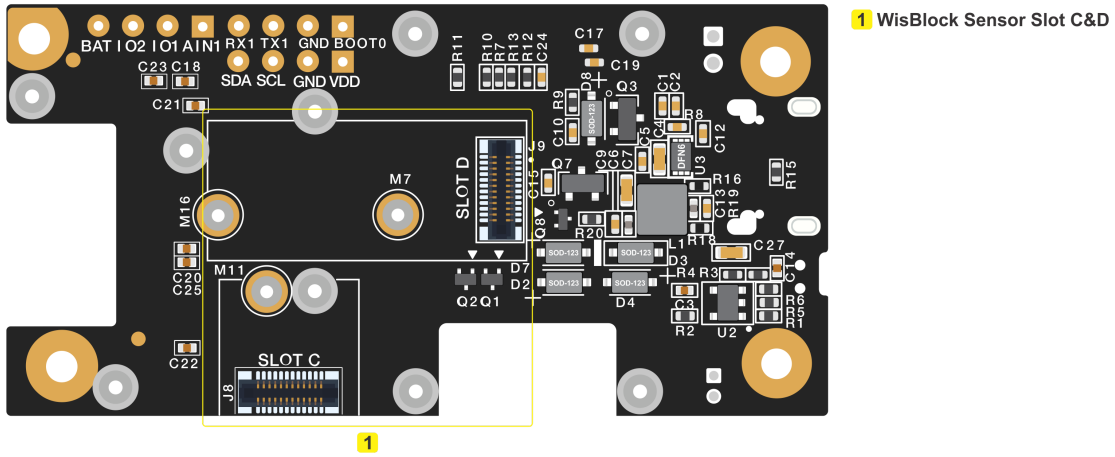

Figure 5: RAK19007 bottom view components

Type-C USB port

The Type-C USB connector is compliant with the USB 2.0 specification. This USB interface directly communicates with the connected **WisBlock Core** module. It is also used as a charging input port for the battery. Here are some of the advantages of the Type-C USB connector:

- Smaller and reversible connector shape
- Port can be input or output
- Fast battery charging

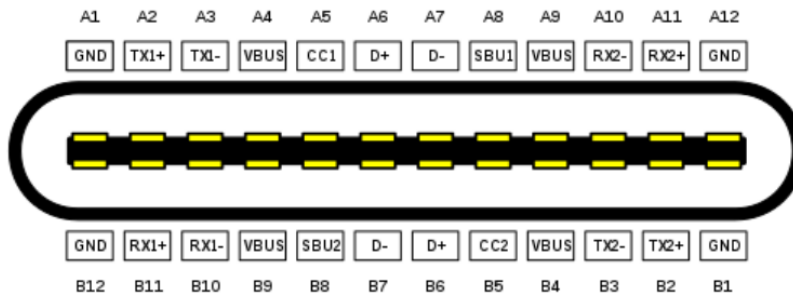

Figure 6: USB Type-C receptacle pinout

J10, J11, J12 Headers

On the RAK19007 Base Board, there are three 2.54 mm pitch headers for IO extension. BOOT, I2C, GPIO, and UART pins from the WisBlock Core module are also connected to these headers.

J10 Header Pinout

Pin	Pin Name	Description
1	BOOT	MCU BOOT pin
2	GND	Ground pin
3	TX1	UART1 TX pin
4	RX1	UART1 RX pin

J11 Header Pinout

Pin	Pin Name	Description
1	AIN1	ADC input signal
2	IO1	General purpose IO
3	IO2	General purpose IO
4	VBAT	Battery voltage

J12 Header Pinout

Pin	Pin Name	Description
1	VDD	3.3 V
2	GND	Ground pin
3	SCL	I2C1 clock
4	SDA	I2C2 data

NOTE BOOT pin

BOOT pin is used on startup configuration or sequence of the WisBlock Core connected to it. It is commonly used for uploading the bootloader and/or application firmware. The requirements of the state of the BOOT pin depend on the specific model of the WisBlock Core used.

Battery Connector

Figure 7 shows the battery connector V+(VBAT) and V-(GND).

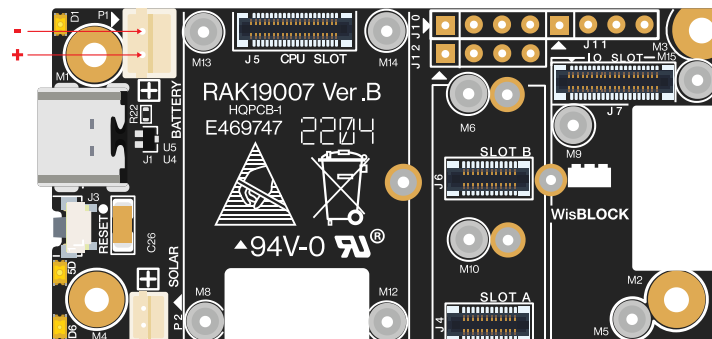

Figure 7: Battery connector pin order

WARNING

The voltage of the battery **must not exceed 4.3 V**.

Solar Panel Connector

Figure 8 shows the solar panel connector V+(Vin) and V-(GND)

Function Name of WisBlock Base	Pin Number	Pin Number	Function Name of WisBlock Base
VBAT	1	2	VBAT
GND	3	4	GND
3V3	5	6	3V3
USB+	7	8	USB-
VBUS	9	10	SW1
TXD0	11	12	RXD0
RESET	13	14	LED1
LED2	15	16	LED3
VDD	17	18	VDD
I2C1_SDA	19	20	I2C1_SCL
AIN0	21	22	AIN1
BOOT0	23	24	IO7
SPI_CS	25	26	SPI_CLK
SPI_MISO	27	28	SPI_MOSI
IO1	29	30	IO2
IO3	31	32	IO4
TXD1	33	34	RXD1
I2C2_SDA	35	36	I2C2_SCL
IO5	37	38	IO6
GND	39	40	GND

As for the following table, it shows the definition of each pin of the WisBlock Core connector:

Pin Number	Pin Name	Type	Description
1	VBAT	S	Power supply from battery
2	VBAT	S	Power supply from battery
3	GND	S	Ground
4	GND	S	Ground
5	3V3	S	3.3 V power supply
6	3V3	S	3.3 V power supply
7	USB+	I/O	USB D+
8	USB-	I/O	USB D-
9	VBUS	S	VBUS for USB
10	SW1	I/O	Switch signal for customer's control
11	TXD0	I/O	MCU UART0 TX signal
12	RXD0	I/O	MCU UART0 RX signal
13	RESET	I	Connected to the reset switch, for MCU reset
14	LED1	I/O	LED for battery charging indication
15	LED2	I/O	LED for custom usage
16	LED3	I/O	LED for custom usage
17	VDD	S	Generated by MCU module for power sensor board if the MCU IO level is not 3.3 V
18	VDD	S	Generated by MCU module for power sensor board if the MCU IO level is not 3.3 V
19	I2C1_SDA	I/O	The first set of I2C data signal
20	I2C1_SCL	I/O	The first set of I2C clock signal
21	AIN0	A	Analog input for ADC
22	AIN1	A	Analog input for ADC
23	BOOT0	I	For ST MCU, set high when reset. The MCU will allow you to enter boot mode.

Pin Number	Pin Name	Type	Description
24	IO7	I/O	Not connected
25	SPI_CS	I/O	SPI chip select signal
26	SPI_CLK	I/O	SPI clock
27	SPI_MISO	I/O	SPI MISO signal
28	SPI_MOSI	I/O	SPI MOSI signal
29	IO1	I/O	General purpose IO
30	IO2	I/O	Used for 3V3_S enable
31	IO3	I/O	General purpose IO
32	IO4	I/O	General purpose IO
33	TXD1	I/O	MCU UART1 RX signal
34	RXD1	I/O	MCU UART1 RX signal
35	I2C2_SDA	I/O	The second set of I2C data signal
36	I2C2_SCL	I/O	The second set of I2C data signal
37	IO5	I/O	General purpose IO
38	IO6	I/O	General purpose IO
39	GND	S	Ground
40	GND	S	Ground

Connectors for WisBlock Sensor

The WisBlock sensor module connector is a **24-pin board-to-board connector**.

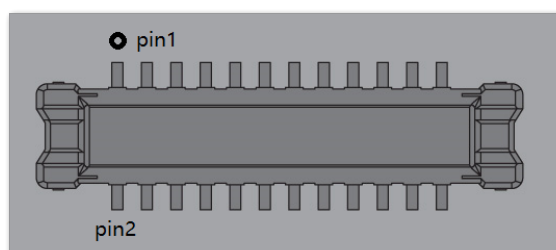

Figure 10: WisBlock Sensor module connector

 **NOTE**

There are four connectors reserved for the sensor modules on the RAK19007. The pinout definition of the WisBlock modules with 24-pin connector on WisBlock Mini Base varies according to its connector.

Connector D	Connector C	Connector B	Connector A	Pin Number	Pin Number	Connector A	Connector B
TXD1	NC	NC	TXD1	1	2	GND	GI
SPI_CS	SPI_CS	SPI_CS	SPI_CS	3	4	SPI_CLK	SF
SPI_MISO	SPI_MISO	SPI_MISO	SPI_MISO	5	6	SPI_MOSI	SF
I2C1_SCL	I2C1_SCL	I2C1_SCL	I2C1_SCL	7	8	I2C1_SDA	I2C
VDD	VDD	VDD	VDD	9	10	IO2	IO
3V3_S	3V3_S	3V3_S	3V3_S	11	12	IO1	IO
NC	NC	NC	NC	13	14	3V3_S	3V
NC	NC	NC	NC	15	16	VDD	VE
NC	NC	NC	NC	17	18	NC	NC
NC	NC	NC	NC	19	20	NC	NC
NC	NC	NC	NC	21	22	NC	NC
GND	GND	GND	GND	23	24	RXD1	NC

As for the following table, it shows the pin name and description of each pin in the WisBlock Sensor module connector.

Pin Number	Connector A	Connector B	Connector C	Connector D	Type	Description
1	TXD1	NC	NC	TXD1	I/O	UART TX signal
2	GND	GND	GND	GND	S	Ground
3	SPI_CS	SPI_CS	SPI_CS	SPI_CS	I/O	SPI chip select signal
4	SPI_CLK	SPI_CLK	SPI_CLK	SPI_CLK	I/O	SPI clock
5	SPI_MISO	SPI_MISO	SPI_MISO	SPI_MISO	I/O	SPI MISO signal
6	SPI_MOSI	SPI_MOSI	SPI_MOSI	SPI_MOSI	I/O	SPI MOSI signal
7	I2C1_SCL	I2C1_SCL	I2C1_SCL	I2C1_SCL	I/O	I2C clock signal
8	I2C1_SDA	I2C1_SDA	I2C1_SDA	I2C1_SDA	I/O	I2C data signal
9	VDD	VDD	VDD	VDD	S	Generated by CPU module. Used to power sensor board if MCU IO level is not 3.3 V
10	IO2	IO1	IO4	IO6	I/O	General purpose IO. IO2 controls the power switch of 3V3_S. When the 3V3_S function is used, IO2 can not be used as an interrupt of the sensor.
11	3V3_S	3V3_S	3V3_S	3V3_S	S	3.3 V power supply. Can be shut down by the CPU module.
12	IO1	IO2	IO3	IO5	I/O	General purpose IO - IO controls the power switch of 3V3_S. When the 3V3_S function is used, IO2 cannot be used as an interrupt of the sensor.
13	NC	NC	NC	NC	NC	Not connected

Pin Number	Connector A	Connector B	Connector C	Connector D	Type	Description
14	3V3_S	3V3_S	3V3_S	3V3_S	S	3.3 V power supply. Can be shut down by the CPU module.
15	NC	NC	NC	NC	NC	Not connected
16	VDD	VDD	VDD	VDD	S	Generated by CPU module. Used to power sensor board if the MCU IO level is not 3.3 V.
17	NC	NC	NC	NC	NC	Not connected
18	NC	NC	NC	NC	NC	Not connected
19	NC	NC	NC	NC	NC	Not connected
20	NC	NC	NC	NC	NC	Not connected
21	NC	NC	NC	NC	NC	Not connected
22	NC	NC	NC	NC	NC	Not connected
23	GND	GND	GND	GND	S	Ground
24	RXD1	NC	NC	RXD1	I/O	UART RX signal

Electrical Characteristics

Absolute Maximum Ratings

The Absolute Maximum Ratings of the device are shown in the table below. The stress ratings are the functional operation of the device.

WARNING

1. If the stress rating goes above what is listed, it may cause permanent damage to the device.
2. Under the listed conditions is not advised.
3. Exposure to maximum rating conditions may affect the device reliability.

Ratings	Maximum Value	Unit
Power supply on the USB port (VBUS)	-0.3 to 5.5	V
Battery voltage (VBAT)	-0.3 to 4.3	V
Solar panel voltage (CONN_S)	-0.3 to 5.5	V
IOs of WisBlock connector	-0.3 to VDD+0.3	V
ESD	2000	V

WARNING

The RAK19007, as any electronic equipment, is sensitive to **electrostatic discharge (ESD)**. Improper handling can cause permanent damage to the module.

Current Consumption

The RAK19007 is designed for **low-power IoT products**, and the power supply uses a high-efficiency low grounding current regulator. When there is no module on RAK19007, the **leakage current is lower than 2 μ A**. With WisBlock Core and WisBlock Sensor on it, the sleep current is **lower than 10 μ A**. When a LoRa module is transmitting, the current may reach **130 mA**.

Conditions	Current	Unit
Leakage current, without any module on RAK19007	2	μ A
Idle current, with MCU and sensors in sleep mode	10	μ A
Working current, with LoRa module transmitting	130	mA

Battery Connector

The RAK19007 WisBlock Base Board 2nd Gen can be powered by a rechargeable battery, connected to the **P2 connector**. The nominal operating voltage of the battery should be within the range shown in the following table. The matching connector for the battery wires is an [JST PHR-2 2 mm pitch female](#) 

Minimum	Typical	Maximum	Unit
3.3	3.7	4.3	V

The Type-C USB connector is used as a charging port. The voltage and current fed to the battery through the port should not exceed its charging limits, as shown in the table below.

Parameter	Value
Charging voltage	4.5 – 5.5 V
Charging current	350 mA

A suitable Li-Ion battery should have the following parameters as shown in the table below:

Parameter	Value
Standard voltage	3.7 V
Charging voltage	4.2 V
Capacity	As required
Discharge current	At least 500 mA

NOTE

Do not use a non-rechargeable battery.

Solar Panel Connector

A 5 V solar panel can be connected to the board via the **P1 connector**. The solar panel can also be used to charge the Li-Ion battery. The matching connector for the solar panel wires is an [JST ZHR-2 1.5 mm pitch female](#) .

Mechanical Characteristics

Board Dimensions

Figure 11 shows the detailed mechanical dimensions of the RAK19007 Board.

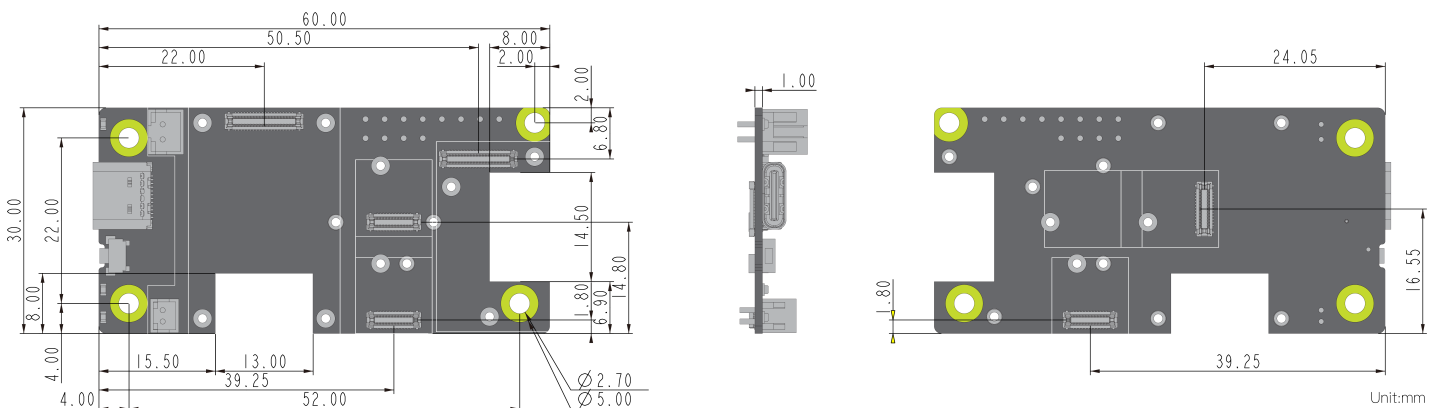

Figure 11: RAK19007 mechanical dimensions

Figure 12 and **Figure 13** show the mounting holes location and diameter of the RAK19007 Board.

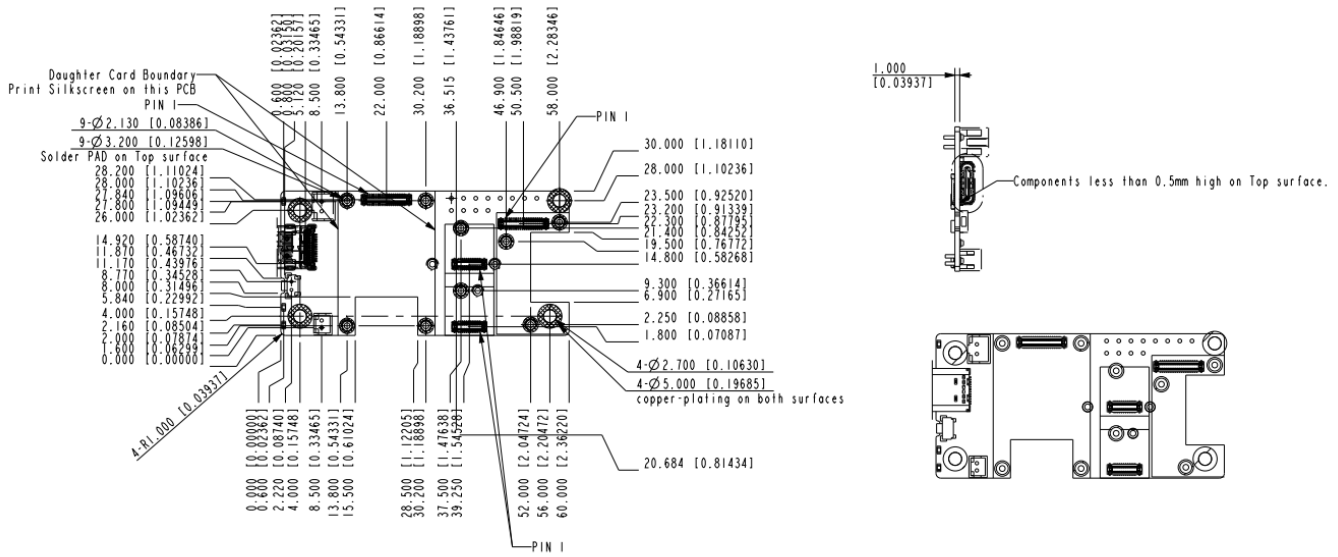

Figure 12: RAK19007 mounting holes location and diameter top view

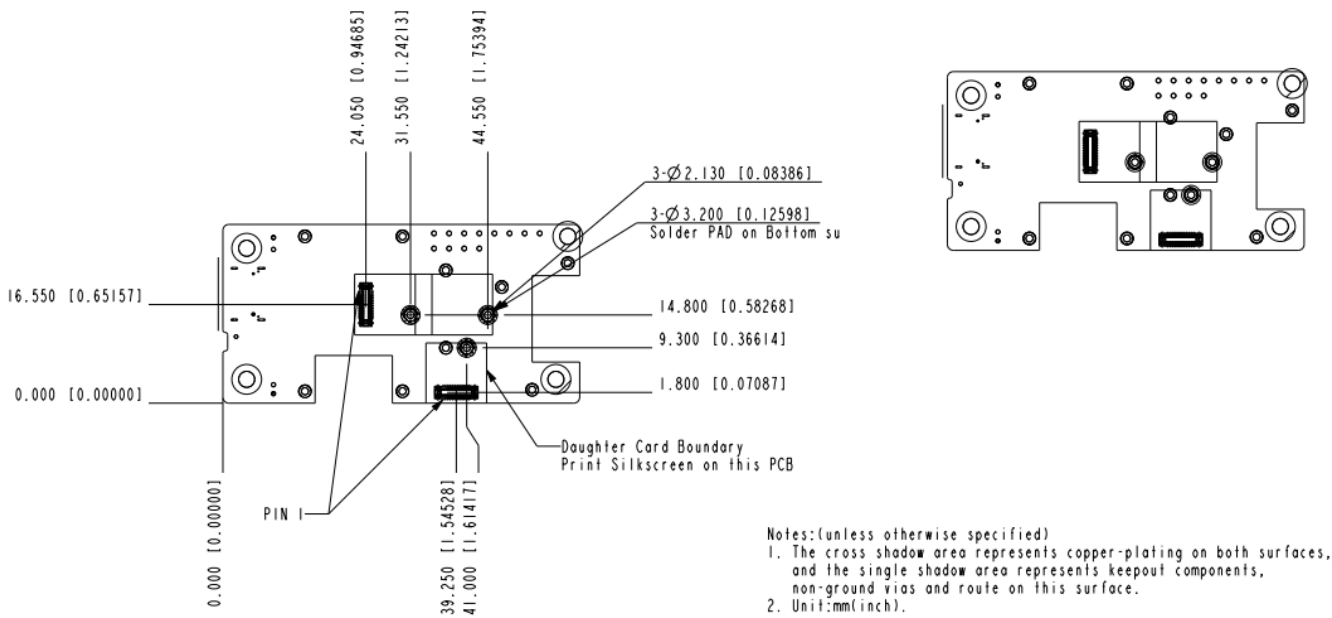

Figure 13: RAK19007 mounting holes location and diameter bottom view

WisConnector PCB Layout

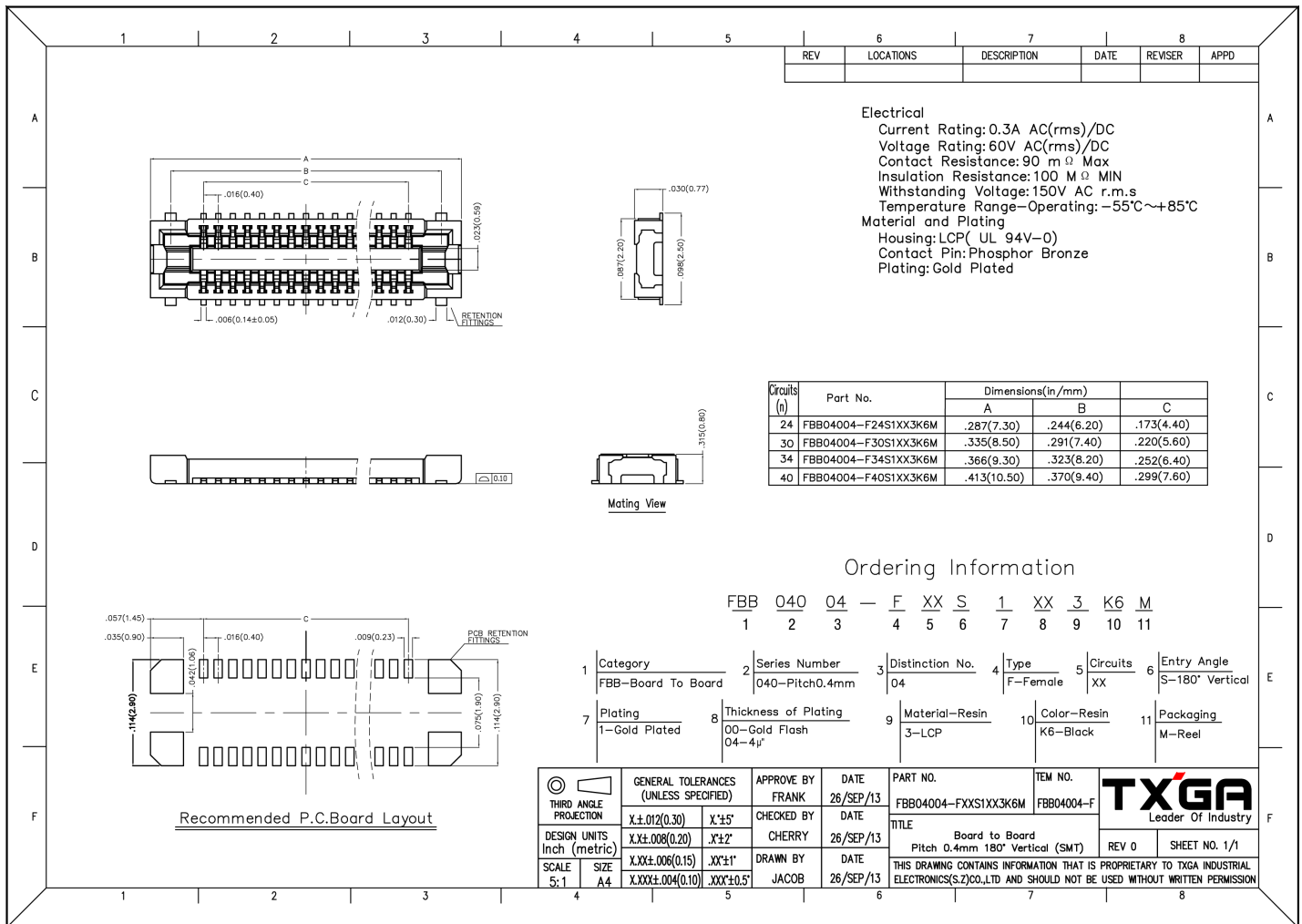

Figure 14: WisConnector PCB footprint and recommendations

Environmental Characteristics

The table below lists the operation and storage temperature requirements of RAK19007:

Parameter	Minimum	Typical	Maximum
Operational Temperature Range	-35 °C	+25 °C	+75 °C
Extended Temperature Range	-40 °C	+25 °C	+80 °C
Storage Temperature Range	-40 °C	+25 °C	+80 °C

Schematic Diagram

The component schematics diagram of the RAK19007 is shown in **Figure 15** and **Figure 16**.

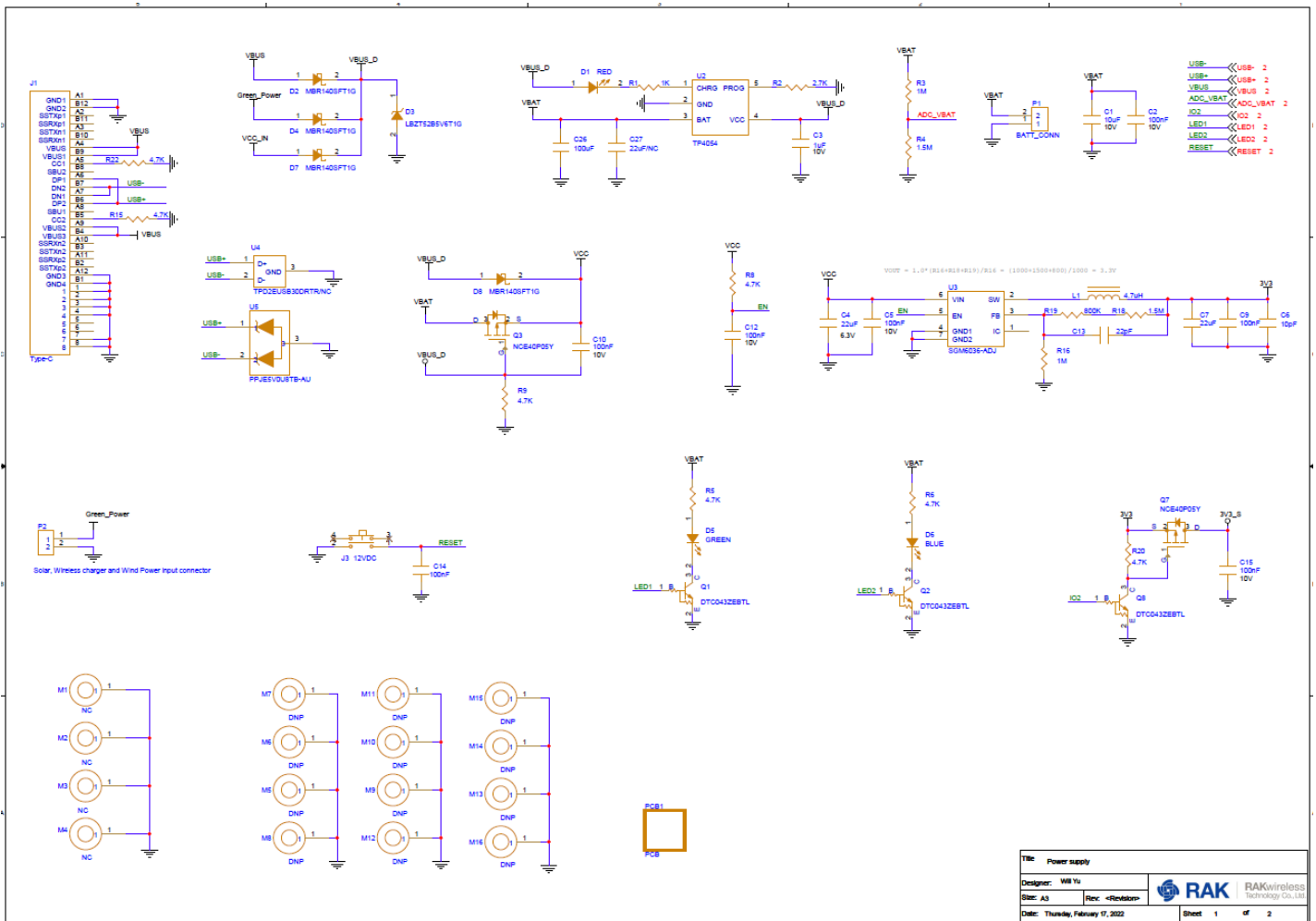

Figure 15: RAK19007 schematic diagram (Power)

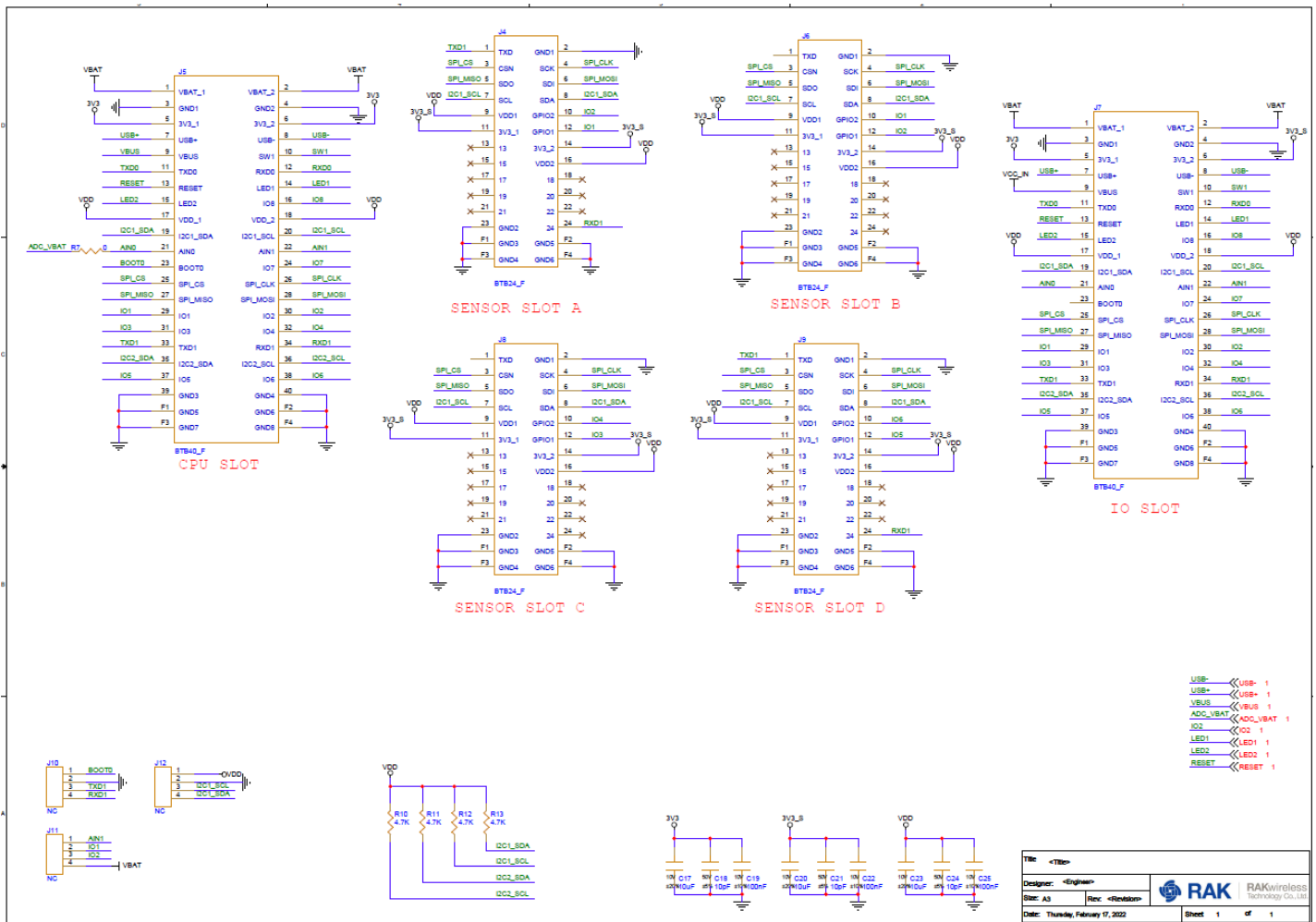

Figure 16: RAK19007 schematic diagram (Slots)